SB-122-1J64

**Industrial Fanless PC w/Intel® Elkhart Lake
Celeron J6412 Processor**

User's Manual

Version 1.0

CE



2024.07

Revision History

Version	Date	Description
1.0	2024.07	Initial release

Revision History	ii
Contents	i
Preface.....	iii
Copyright Notice	iii
Declaration of Conformity	iii
CE.....	iii
FCC Class A	iii
RoHS	iv
SVHC / REACH	iv
Important Safety Instructions	v
Warning.....	vi
Lithium Battery Replacement.....	vi
Technical Support	vi
Warranty.....	vii
Chapter 1 - Introduction.....	1
1.1. Features.....	2
1.2. About this Manual	2
1.3. Ordering Information	2
1.4. Specifications.....	3
1.5. Inside the Package	4
Chapter 2 - Getting Started.....	5
2.1. Dimensions	6
2.2. Overview	6
2.2.1. Front side View	6
2.2.2 DC-IN Power Input.....	7
2.2.3 HDMI/DP Output.....	7
2.2.4 Serial Port Connector(COM1, COM2).....	8
2.2.5 USB Port.....	8
2.2.6 LAN Port	9
2.2.7 Power LED Status	9
2.2.8 Antenna Hole	10
2.3 Internal Connector / Jumper	10
2.3.1 M.2 2242.....	11
2.3.2 DDR4 SO-DIMM socket.....	12
2.3.3 AT/ATX Selection Jumper(JP23)	12
2.3.4 JFP1 Pin definition.....	12
2.3.5 GPIO Jump	12
2.3.6 M.2 2230.....	14
Chapter 3 - Engine of the Computer	15

- 3.1. Installation and Maintenance 16
- 3.2. Install M.2 2242 Storage/Thermal Pad 17
- 3.3. Mounting 18
 - 3.3.1 Wall mounting 18
 - 3.3.2 DIN-rail mounting 19
- Chapter 5 - BIOS 21**
- 4.1. Main - Sets system Time & Date 24
- 4.2. Advanced 25
 - 4.2.1. Turbo Mode Setting 26
 - 4.2.2. COM Mode Setting 27
- 4.3. USB Power Setting in Power Off / Hibernation Mode 29
- 4.4. GPIO Setting 31
- 4.5. Auto TURN-ON (AT/ATX) 32
- 4.6. Security 33
- 4.7. Boot 34
- 4.8. Setting the Boot Logo 35
- 4.9. Setting Boot Option Priority 36
- 4.10. Save & Exit 37

Copyright Notice

All Rights Reserved.

The information in this document is subject to change without prior notice in order to improve the reliability, design and function. It does not represent a commitment on the part of the manufacturer.

Under no circumstances will the manufacturer be liable for any direct, indirect, special, incidental, or consequential damages arising from the use or inability to use the product or documentation, even if advised of the possibility of such damages.

This document contains proprietary information protected by copyright. All rights are reserved. No part of this document may be reproduced by any mechanical, electronic, or other means in any form without prior written permission of the manufacturer.

Declaration of Conformity

CE

The CE symbol on your product indicates that it is in compliance with the directives of the Union European (EU). A Certificate of Compliance is available by contacting Technical Support.

This product has passed the CE test for environmental specifications when shielded cables are used for external wiring. We recommend the use of shielded cables. This kind of cable is available from ARBOR. Please contact your local supplier for ordering information.

Warning

This is a class A product. In a domestic environment this product may cause radio interference in which case the user may be required to take adequate measures.

FCC Class A

This device complies with Part 15 of the FCC Rules. Operation is subject to the following two conditions:

- (1) This device may not cause harmful interference, and
- (2) This device must accept any interference received, including interference that may cause undesired operation.

NOTE:

This equipment has been tested and found to comply with the limits for a Class A digital device, pursuant to Part 15 of the FCC Rules. These limits are designed to provide reasonable protection against harmful interference when the equipment is operated in a commercial environment. This equipment generates, uses, and can radiate radio frequency energy and, if not installed and used in accordance with the instruction manual, may cause harmful interference to radio communications. Operation of this equipment in a residential area is likely to cause harmful interference in which case the user will be required to correct the interference at his own expense.

RoHS

ARBOR Technology Corp. certifies that all components in its products are in compliance and conform to the European Union's Restriction of Use of Hazardous Substances in Electrical and Electronic Equipment (RoHS) Directive 2002/95/EC.

The above mentioned directive was published on 2/13/2003. The main purpose of the directive is to prohibit the use of lead, mercury, cadmium, hexavalent chromium, polybrominated biphenyls (PBB), and polybrominated diphenyl ethers (PBDE) in electrical and electronic products. Member states of the EU are to enforce by 7/1/2006.

ARBOR Technology Corp. hereby states that the listed products do not contain unintentional additions of lead, mercury, hex chrome, PBB or PBDB that exceed a maximum concentration value of 0.1% by weight or for cadmium exceed 0.01% by weight, per homogenous material. Homogenous material is defined as a substance or mixture of substances with uniform composition (such as solders, resins, plating, etc.). Lead-free solder is used for all terminations (Sn(96-96.5%), Ag(3.0-3.5%) and Cu(0.5%)).

SVHC / REACH

To minimize the environmental impact and take more responsibility to the earth we live, Arbor hereby confirms all products comply with the restriction of SVHC (Substances of Very High Concern) in (EC) 1907/2006 (REACH --Registration, Evaluation, Authorization, and Restriction of Chemicals) regulated by the European Union.

All substances listed in SVHC < 0.1 % by weight (1000 ppm)

Important Safety Instructions

Read these safety instructions carefully

1. Read all cautions and warnings on the equipment.
2. Place this equipment on a reliable surface when installing. Dropping it or letting it fall may cause damage
3. Make sure the correct voltage is connected to the equipment.
4. For pluggable equipment, the socket outlet should be near the equipment and should be easily accessible.
5. Keep this equipment away from humidity.
6. The openings on the enclosure are for air convection and protect the equipment from overheating. **DO NOT COVER THE OPENINGS.**
7. Position the power cord so that people cannot step on it. Do not place anything over the power cord.
8. Never pour any liquid into opening. This may cause fire or electrical shock.
9. Never open the equipment. For safety reasons, the equipment should be opened only by qualified service personnel.
10. If one of the following situations arises, get the equipment checked by service personnel:
 - a. The power cord or plug is damaged.
 - b. Liquid has penetrated into the equipment.
 - c. The equipment has been exposed to moisture.
 - d. The equipment does not work well, or you cannot get it to work according to the user's manual.
 - e. The equipment has been dropped or damaged.
 - f. The equipment has obvious signs of breakage.
11. Keep this User's Manual for later reference.

Warning

The Box PC and its components contain very delicately Integrated Circuits (IC). To protect the Box PC and its components against damage caused by static electricity, you should always follow the precautions below when handling it:

1. Disconnect your Box PC from the power source when you want to work on the inside.
2. Use a grounded wrist strap when handling computer components.
3. Place components on a grounded antistatic pad or on the bag that came with the Box PC, whenever components are separated from the system.

Lithium Battery Replacement

Incorrect replacement of the lithium battery may lead to a risk of explosion.

The lithium battery must be replaced with an identical battery or a battery type recommended by the manufacturer.

Do not throw lithium batteries into the trash can. It must be disposed of in accordance with local regulations concerning special waste.

Technical Support

If you have any technical difficulties, please consult the user's manual first at:
<https://www.arbor-technology.com>

Please do not hesitate to call or e-mail our customer service when you still cannot find out the answer.

<https://www.arbor-technology.com>

E-mail: info@arbor.com.tw

Warranty

This product is warranted to be in good working order for a period of two year from the date of purchase. Should this product fail to be in good working order at any time during this period, we will, at our option, replace or repair it at no additional charge except as set forth in the following terms. This warranty does not apply to products damaged by misuse, modifications, accident or disaster.

Vendor assumes no liability for any damages, lost profits, lost savings or any other incidental or consequential damage resulting from the use, misuse of, or inability to use this product. Vendor will not be liable for any claim made by any other related party.

Vendors disclaim all other warranties, either expressed or implied, including but not limited to implied warranties of merchantability and fitness for a particular purpose, with respect to the hardware, the accompanying product's manual(s) and written materials, and any accompanying hardware. This limited warranty gives you specific legal rights.

Return authorization must be obtained from the vendor before returned merchandise will be accepted. Authorization can be obtained by calling or faxing the vendor and requesting a Return Merchandise Authorization (RMA) number. Returned goods should always be accompanied by a clear problem description.

This page is intentionally left blank.

Chapter 1

Introduction

1.1. Features

- Intel® Celeron® J6412 CPU Elkhart Lake(2.0 GHz/2.6GHz)
- Support HDMI/DP Video outputs, resolution up to 4K@60Hz
- 4 USB ports (2 x USB2.0 + 2 x USB3.1)
- Small size(Palm-size), convenient to install
- All Aluminum Chassis enable excellent heat dissipation

1.2. About this Manual

This manual is meant for the experienced users and integrators with hardware knowledge of personal computers. If you are not sure about the description in this manual, consult your vendor before further handling.

We recommend that you keep one copy of this manual for the quick reference for any necessary maintenance in the future. Thank you for choosing ARBOR products.

1.3. Ordering Information

SB-122-1J64	Barebone Fanless System, Intel Elkhart Lake series J6412, 2 x LAN, DP/HDMI, 4 x USB, 2 x COM, DC 12-24V power input
SB-122-1J64-R4S128	Fanless System with 4GB RAM & 128GB SSD, Intel Elkhart Lake series J6412, 2 x LAN, DP/HDMI, 4 x USB, 2 x COM, DC 12-24V power input

1.4. Specifications

System	
CPU	Intel® Celeron® J6412 CPU Elkhart Lake (2.0 GHz/2.6GHz)
Memory	1 x SDRAM DDR4 3200 MHz SO-SIMM slot (max. 32G) 4GB DDR4 SO-DIMM pre-installed*(CTOS)
Graphics	Intel® UHD Graphics for 10 th Gen Intel® Processors
LAN Chipset	1 x Intel I210AT GbE controller 1 x Intel I226-V 2.5GbE controller
Watchdog Timer	Programmable 255 levels timer interval, from 1~255 sec/min
Storage	
Device	1 x M.2 2242 slot (SATA3.0) 128GB M.2 SSD pre-installed*(CTOS)
External I/O	
Serial Ports	2 x RS-232/422/485 (default RS-232) with auto flow control
USB Ports	2 x USB3.1 2 x USB2.0
LAN	2 x RJ45
Video Port	1 x HDMI up to 4096 x 2160 @ 24 Hz
	1 x DP up to 4096 x 2160 @ 60 Hz
Internal I/O	
Expansion Slot	1 x Mini-PCIe slot (PCIe/ USB2.0 signal supported) 1 x E-Key M.2 2230 slot (PCIe/USB2.0 signal supported)
USB	2 x USB2.0
Mechanical	
Chassis	Aluminum Alloy
Mounting	Desk-Mount, Wall-Mount, DIN-Rail(optional)
Dimension (W x H x D)	165 x 120 x 50 mm
Weight (Net)	0.8kg

Environmental	
Operating Temp.	-20 ~ 60°C (-4 ~ 140°F)
Storage Temp.	-40 ~ 85°C (-40 ~ 185°F)
Relative Humidity	5 ~ 95% (non-condensing)
Vibration	5~500Hz, 2Grms operation
Sine Vibration	5~500Hz, 2G, Non-operation
Shock	Operation: 10G@11ms Non-operation: 30G@11ms
Qualification	
Certification	CE, FCC
Power System	
Power Input	12-24V DC, 2-pin phoenix connector
OS Support	
Windows 10 Ubuntu 20.04	

1.5. Inside the Package

Upon opening the package, carefully inspect the contents. If any of the items is missing or appears damaged, contact your local dealer or distributor. The package should contain the following items:



1 x SB-122-1J64



- User's manual
- 1 x M.2 2242 thermal pad
- 1 x Memory thermal pad
- 1 x M2 screw
- 1 x pan head screw

Chapter 2

Getting Started

2.1. Dimensions

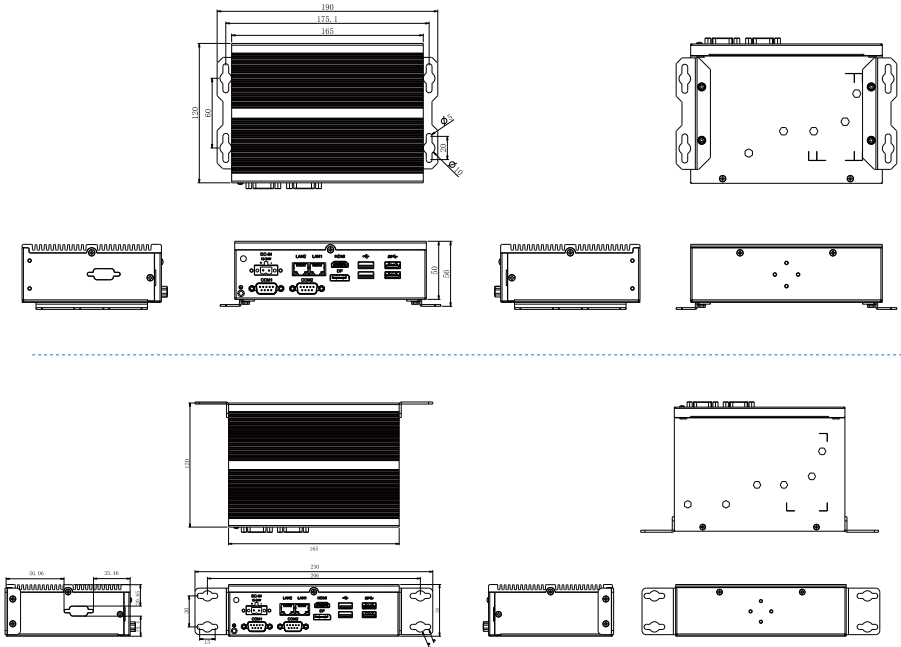

2.2. Overview

2.2.1. Front side View

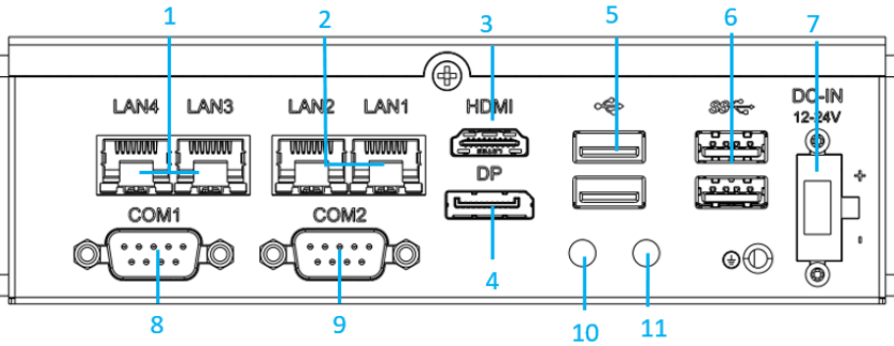

Front Side Panel List

No.	Item	No.	Item
1	LAN3/4	7	DC-IN
2	LAN1/2	8	Com1
3	HDMI	9	Com2
4	DP	10	POWER_LED
5	USB2.0	11	HDD_LED
6	USB3.0		

2.2.2 DC-IN Power Input

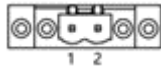

Pin	Pin Definition	Pin	Pin Definition
1	+12~24V	2	GND

2.2.3 HDMI/DP Output

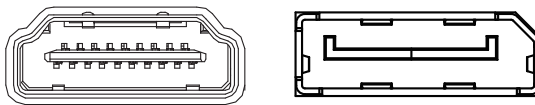

Figure 2.2.2-1 HDMI / DP Connector

2.2.4 Serial Port Connector(COM1, COM2)

COM1, COM2

Function: RS-232/422/485 Selectable Serial Port

Connector Type: External 9-pin D-sub male connector

Pin Assignment:

	Pin	Desc.	Pin	Desc
RS-232	1	DCD	6	DSR
	2	RXD	7	RTS
	3	TXD	8	CTS
	4	DTR	9	RI
	5	GND		
RS-422	1	Tx-		
	2	Tx+		
	3	Rx+		
	4	Rx-		
	5	GND		
RS-485	1	Data-	4	NC
	2	Data+	5	GND
	3	NC		

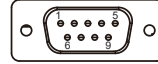

Note: COM1/2 support RS232/422/485.

2.2.5 USB Port

Function: USB 3.1/3.0/2.0 Stacked Connectors

Connector Type: USB 3.0/2.0 type A connectors

Pin Assignment: The pin assignments conform to the industry standard.

USB Ver.	Max Speed	Speed name	Max V/I
USB2.0		High-Speed	DSR 5V/0.5A
USB3.0	5Gbps(500MB/S)	Super-Speed USB	5V/900mA
USB3.1	10Gbps(1000MB/S)	Super-Speed USB	5V/900mA

Note: Support 4 x USB ports, 2 x USB3.1 and 2 x USB2.0

2.2.6 LAN Port

LAN Port

- Function:** RJ-45 port for Giga Lan
- Connector Type:** 4 x RJ-45 connectors that support 10/100/1000Mbps fast Ethernet
- Pin Assignment:** The pin assignments conform to the industry standard.

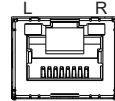

LED Indicators

Indicator	Function	Status
L	Networking Status	Off: not working Green: Working
R	Networking Speed Status	Off: 10Mbps Green: 100Mbps Orange: 1000Mbps

2.2.7 Power LED Status

Description	Status
Power LED Status	Off: Power off or system is in hibernate mode Green LED permanently: Ststem is working

2.2.8 Antenna Hole

There are 2 antenna reserved holes on the rear panel of the product to facilitate users to install the antenna of the wireless module.



2.3 Internal Connector / Jumper

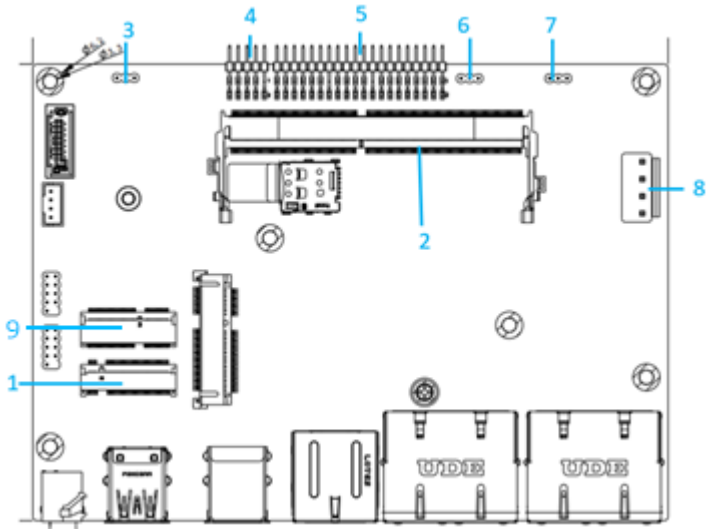

Pin	Pin Definition	Printing
1	M.2 2242	M.2 SSD
2	DDR4 SO-DIMM socket	DIMM1
3	AT/ATX selection mode	ATX_AT
4	Function Reset, LED, Power Button Pin Head	JFP1
5	COM port, GPIO PIN head	J3
6	Clear Cmos Jumper	JCMOS1
7	GPIO	GPIO_V
8	DC-IN	DC-IN
9	M.2 2230 socket	M.2 E-key

2.3.1 M.2 2242

M.2_SSD

Function: M.2 B-Key Connector

Connector Type: M.2 B-Key connector supporting 22x42 modules

Pin Assignment: The pin assignments conform to the industry standard.



2.3.2 DDR4 SO-DIMM socket

Function: 260-pin DDR4 SO-DIMM memory socket
Setting: The Pin assignment conform to the industry standard.

2.3.3 AT/ATX Selection Jumper(JP23)

Function: AT/ATX selection mode

Setting:

Pin	Description
Short 1-2 AT Mode	
Short 2-3 ATX mode	

2.3.4 JFP1 Pin definition

Pin	Description	Pin	Description
1	NC	2	NC
3	PWR_SW	4	HWRST_N
5	GND	6	GND
7	PWR_LED-	8	SATA_LED-
9	PWR_LED+	10	SATA_LED+

2.3.5 GPIO Jump

JGPIO Jump

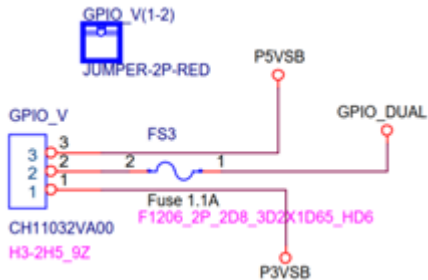

Pin	Description	Pin	Description
1	JGPIO4	2	JGPIO5
3	JGPIO3	4	JGPIO6
5	JGPIO2	6	JGPIO7
7	JGPIO1	8	JGPIO8
9	GPIO_DUAL	10	GPIO_DUAL

Default setting is 3.3V, users is able to set to 5V.

Follow the table as below for the GPIO setting

Pin	GPIO Memory Address	GPI Setting	GPO Setting	GPO High Voltage	GPO Low Voltage
JGPIO1	0xFD6D0980	Bit 8=1 Bit 9=0	Bit 8=0 Bit 9=1	Bit 0=1	Bit 0=0
JGPIO2	0xFD6D0990	Bit 8=1 Bit 9=0	Bit 8=0 Bit 9=1	Bit 0=1	Bit 0=0
JGPIO3	0xFD6D09A0	Bit 8=1 Bit 9=0	Bit 8=0 Bit 9=1	Bit 0=1	Bit 0=0
JGPIO4	0xFD6D09B0	Bit8=1 Bit9=0	Bit8=0 Bit9=1	Bit 0=1	Bit 0=0
JGPIO5	0xFD6D0A10	Bit8=1 Bit9=0	Bit8=0 Bit9=1	Bit 0=1	Bit 0=0
JGPIO6	0xFD6D0A20	Bit8=1 Bit9=0	Bit8=0 Bit9=1	Bit 0=1	Bit 0=0
JGPIO7	0xFD6D0A30	Bit8=1 Bit9=0	Bit8=0 Bit9=1	Bit 0=1	Bit 0=0
JGPIO8	0xFD6D0A40	Bit8=1 Bit9=0	Bit8=0 Bit9=1	Bit 0=1	Bit 0=0

After opening the RW tool, select Memory Dump and fill in the JGPIO1 address value as FD6D0980.

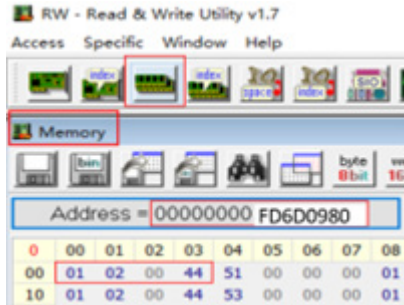

- 32-bit memory address: fill in 0x44000201 for GPO1 High

0	00	01	02	03	04	05	06	07
00	00	02	00	44	51	00	00	00
10	01	02	00	44	53	00	00	00
20	01	02	00	44	55	00	00	00

- 0x44000200 represents GPO1 Low
- 03 position 44 represents GPIO voltage is 3.3V, 84 represents GPIO voltage is 5.0V
- 01 position 02 represents the GPIO pin is GPO state
- 01 position 01 represents the pin of GPIO is GPI state, GPI can only read, but not set.

2.3.6 M.2 2230

Function: M.2 E-Key Connector

Connector Type: M.2 E-key connector supporting 22x30 modules

Pin Assignment: The pin assignments conform to the industry standard.

Chapter 3

Installation & Maintenance

3.1. Installation and Maintenance

1. Remove 2 screws from the bottom panel, as shown in 3.1-1.

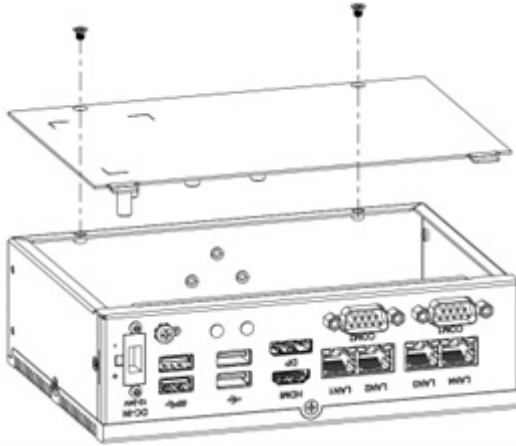

2. Remove 3 screws on front panel, disassembly schematic diagram as 3.1-2

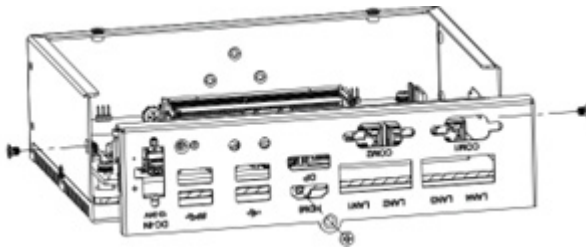

3. Remove 6 screws on the main board, disassemble as shown in 3.1-3.

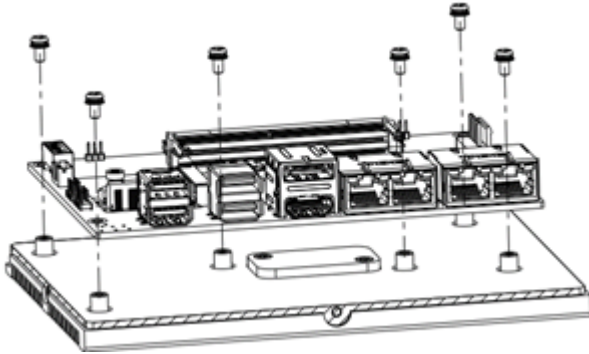

3.2. Install M.2 2242 Storage/Thermal Pad

1. Remove 2 screws on the bottom cover from the computer as described in 3.1-1
2. Install/Remove the storage from the slot and attach the thermal pad to the storage.
3. Attach the accessory hexagonal studs to the screw holes, insert/remove the storage. Fasten 6 screws of P-head M3, and attach the SSD thermal pad to the M.2 SSD.



3.3. Mounting

SB-122-1J64 can support wall mounting and DIN-Rail mounting. DIN-rail mounting require optional mounting brackets.

3.3.1 Wall mounting

1. Take the bracket from the box:
2. Install/Remove the storage from the slot and attach the thermal pad to the storage.
3. Fasten 4 M3 screws, then put the device on a flat surface.

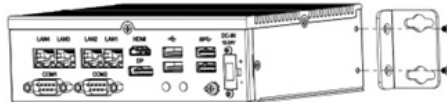
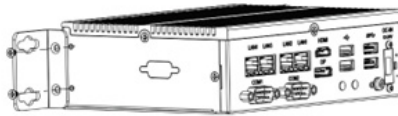

3.3.2 DIN-rail mounting

1. Take the DIN-rail from the box and attach it with 2 screws as below.

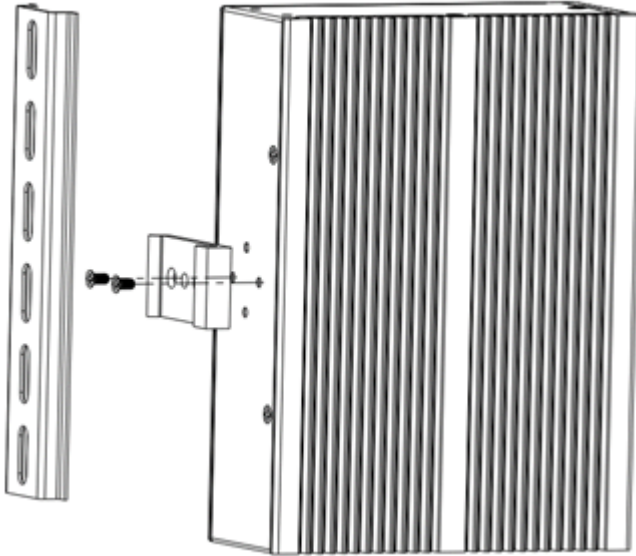

This page is intentionally left blank.

Chapter 4

BIOS

BIOS

The BIOS Setup utility is featured by American Megatrends Inc to configure the system settings stored in the system's BIOS ROM. The BIOS is activated once the computer powers on. When the computer is off, the battery on the main board supplies power to BIOS RAM.

To enter the BIOS Setup utility, keep hitting the "Delete" key upon powering on the computer.



Note: Actual model name and board information varies according to your model.

Key Commands

The BIOS Setup utility relies on a keyboard to receive user's instructions. Hit the following keys to navigate within the utility and use the utility.

Keystroke	Function	
F7	Enter the boot up sequence menu	After System Open
Ctrl + Alt + DEL	Restart the system	
← →	Moves left/right between the top menus.	In BIOS
↓ ↑	Moves up/down between highlight items.	
Enter	Selects an highlighted item/field.	
Page Up / +	Increases current value to the next higher value or switches between available options.	
Page Down / -	Decreases current value to the next lower value or switches between available options.	
F1	Load defaults	
F4	Save the Settings and Quit the BIOS	
Esc	<ul style="list-style-type: none"> ▶ On the top menus: Use Esc to quit the utility without saving changes to CMOS. (The screen will prompt a message asking you to select OK or Cancel to exit discarding changes. ▶ On the submenus: Use Esc to quit current screen and return to the top menu. 	

Note: Pay attention to the "WARNING" that shows at the left pane onscreen when making any change to the BIOS settings.

This BIOS Setup utility is updated from time to time to improve system performance and hence the screenshots hereinafter may not fully comply with what you actually have onscreen.

4.1. Main - Sets system Time & Date.

The **Main** menu features the settings of **System Date** and **System Time** and displays some BIOS info.

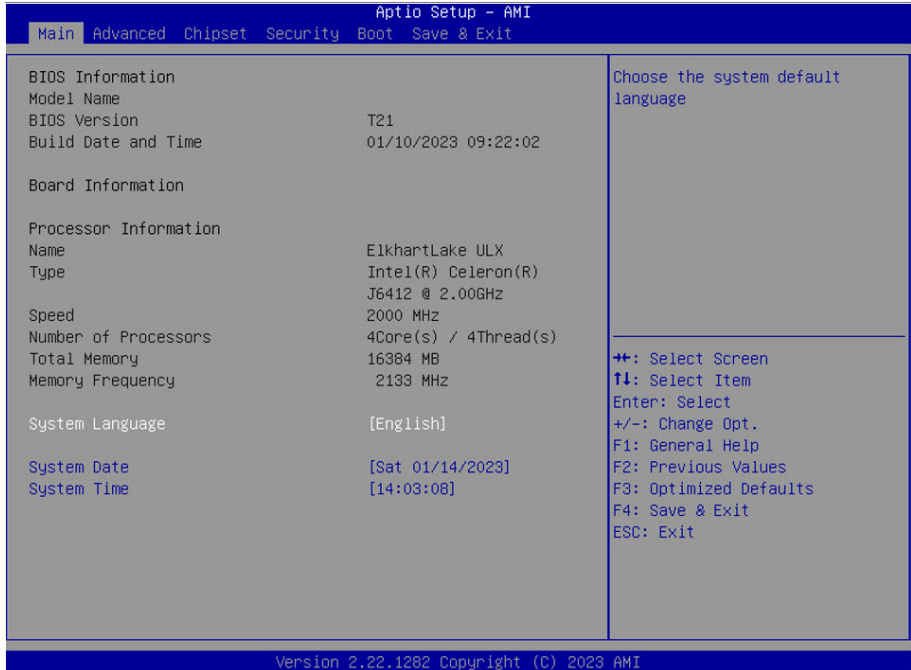

Note: Actual model name and board information varies according to your model.

Setting	Description
System Date	Sets system date.
System Time	Sets system time.

4.2. Advanced

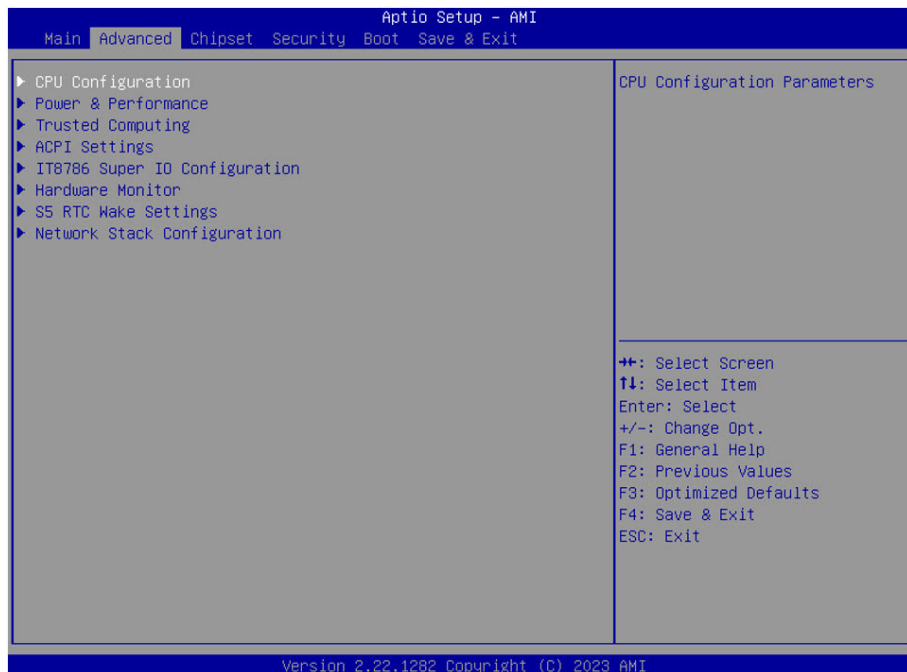

4.2.1. Turbo Mode Setting

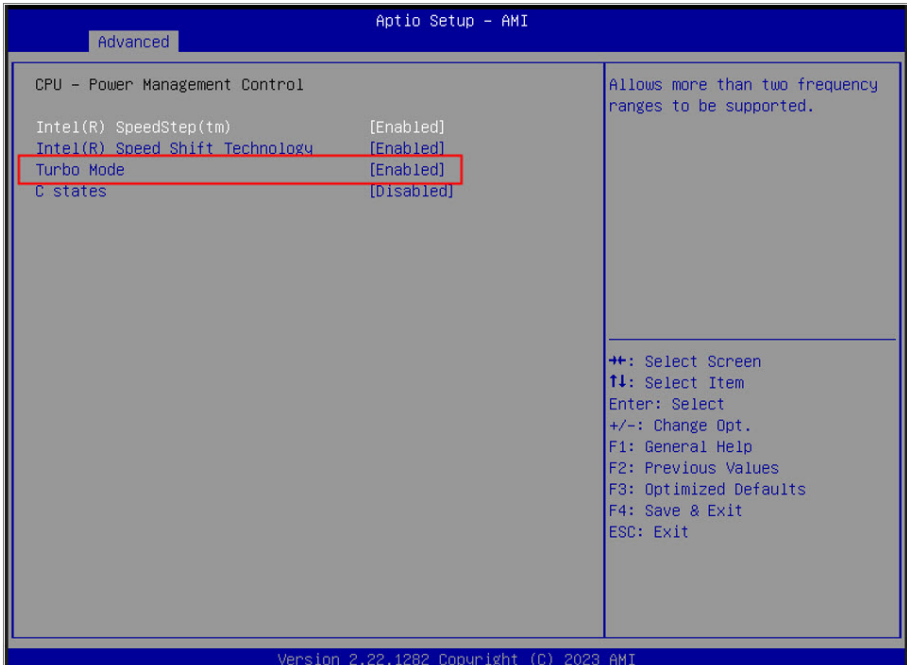

Enter Advanced menu, select **"Power & Performance"** -> **"CPU-Power Management Control"** -> **"Turbo Mode"**. After that users can choose Enabled/Disabled. After setting, press F4 to save and exit, the system will take effect after reboot.

4.2.2. COM Mode Setting



Aptio Setup - AMI	
Advanced	
IT8786 Super IO Configuration	Set Parameters of Serial Port 1 (COMA)
Super IO Chip	IT8786
▶ Serial Port 1 Configuration	
▶ Serial Port 2 Configuration	
▶ Serial Port 3 Configuration	
▶ Serial Port 4 Configuration	
▶ Serial Port 5 Configuration	
▶ Serial Port 6 Configuration	
Watch dog Controller	[Disabled]
COM RI Select	[Disabled]
<hr/>	
⚡: Select Screen ↑↓: Select Item Enter: Select +/-: Change Opt. F1: General Help F2: Previous Values F3: Optimized Defaults F4: Save & Exit ESC: Exit	
Version 2.22.1282 Copyright (C) 2023 AMI	

4.3 USB Power Setting in Power Off / Hibernation Mode

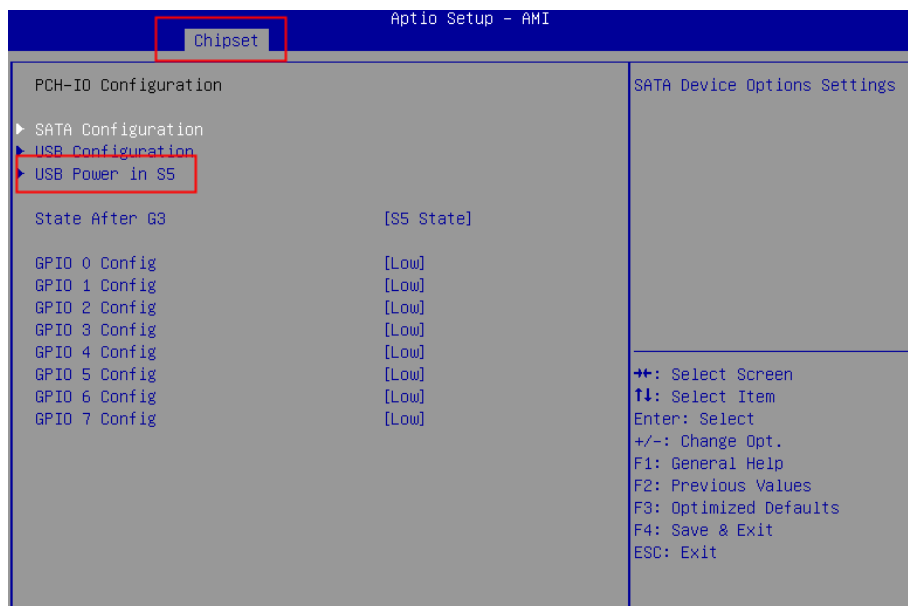

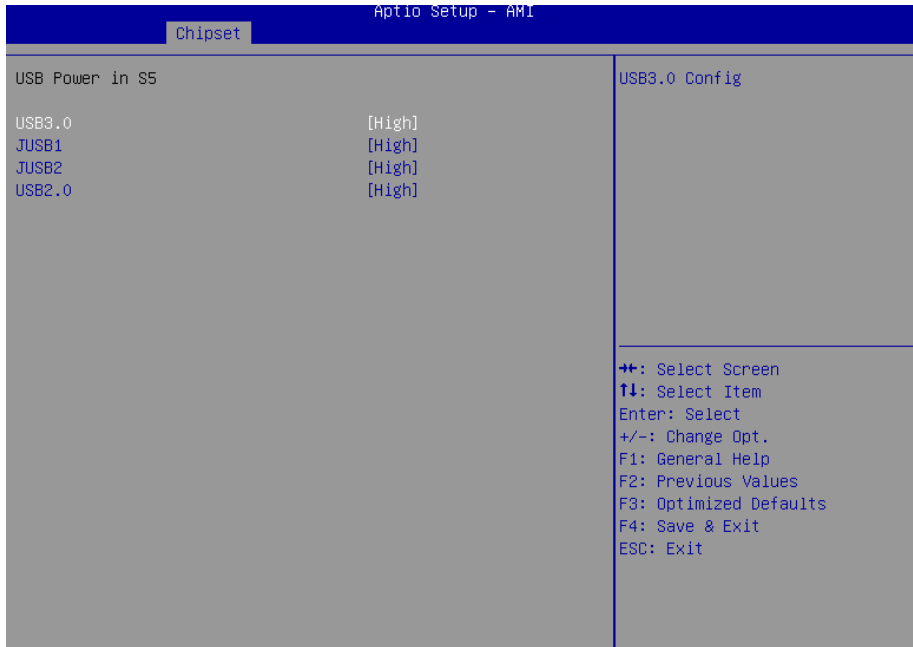

Select "**Chipset**" menu->"**PCH-IO Configuration**"-> "**USB Power in S5**" in order. Users can set the USB power in S5 according to the actual application's requirements and select High or Low to turn it on or off. After setting, press F4 to save and exit, the system will take effect after reboot.

4.4. GPIO Setting

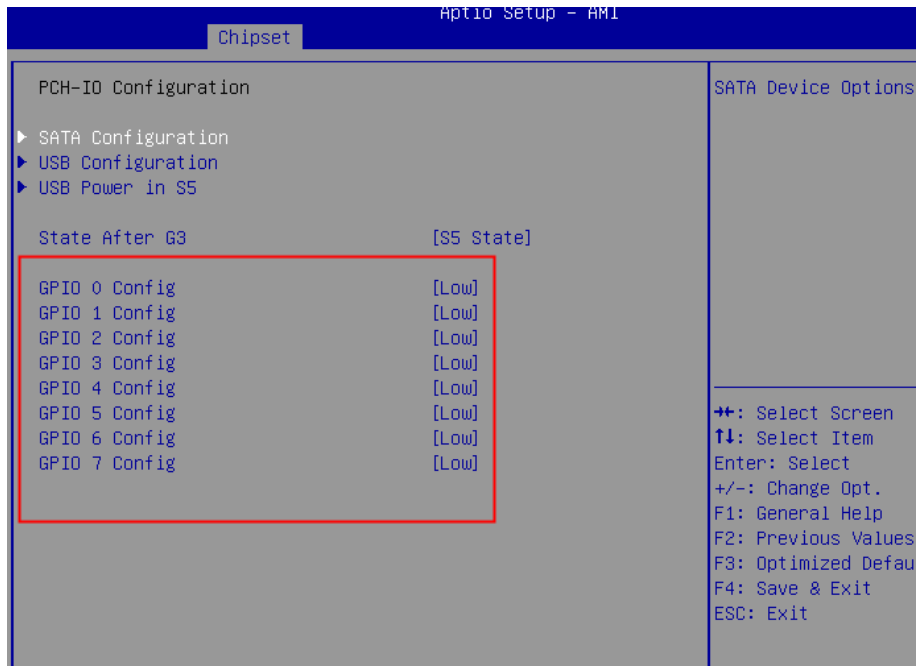

Select "**Chipset**" -> "**PCH-IO Configuration**", and select "**Enable**". Users can set a single GPIO pin as "**GPI**" or "**GPO-High**" or "**GPO-Low**". After setting, press F4 to save and exit, the system will take effect after reboot.

4.5. Auto TURN-ON (AT/ATX)

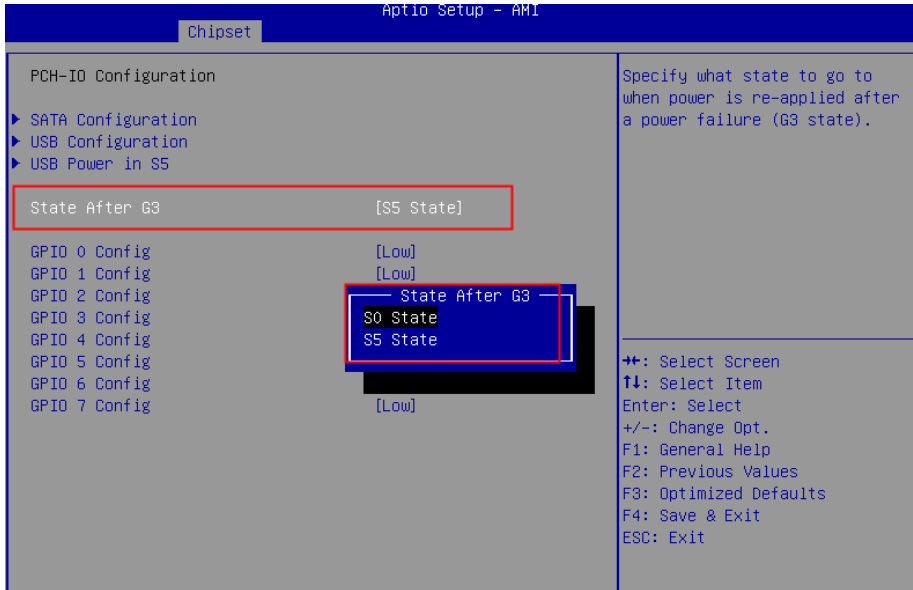

Enter "**Chipset**" menu, and select "**Chipset**"->"**PCH-IO Configuration**"->"**State After G3**" in order. Users can select "**S0 State/S5 State**" for power mode on the system. "**S0 State**" is AT mode, it will power on the system automatically after connecting the power supply, and S5 State is ATX mode. Users need to press the power button to turn on the system after connecting the power supply. **S5 State** is ATX mode. After connecting the power supply, you need to press the power button to power up the device. After setting, press F4 to save and exit, the system will take effect after reboot.

4.6. Security

Aptio Setup Utility - Copyright (C) 2020 American Megatrends, Inc.

Main Advanced Chipset **Security** Boot Save & Exit

<p>Password Description</p> <p>If ONLY the Administrator's password is set, then this only limits access to Setup and is only asked for when entering Setup.</p> <p>If ONLY the User's password is set, then this is a power on password and must be entered to boot or enter Setup. In Setup the User will have Administrator rights.</p> <p>The password length must be in the following range:</p> <table> <tr> <td>Minimum length</td> <td>3</td> </tr> <tr> <td>Maximum length</td> <td>20</td> </tr> </table> <p>Administrator Password User Password</p>	Minimum length	3	Maximum length	20	<p>Set Administrator Password</p> <hr/> <p> ++: Select Screen ↑↓: Select Item Enter: Select +/-: Change Opt. F1: General Help F2: Previous Values F3: Optimized Defaults F4: Save & Exit ESC: Exit </p>
Minimum length	3				
Maximum length	20				

Version 2.18.1263. Copyright (C) 2020 American Megatrends, Inc.

Setting	Description
Adminstration Password	To set up an administrator password: <ol style="list-style-type: none"> 1. Select Administrator Password. 2. An Create New Password dialog then pops up onscreen. 3. Enter your desired password that is no less than 3 characters and no more than 20 characters. 4. Hit [Enter] key to submit.
User Password	To set up an administrator password: <ol style="list-style-type: none"> 1. Select User Password. 2. An Create New Password dialog then pops up onscreen. 3. Enter your desired password that is no less than 3 characters and no more than 20 characters. 4. Hit [Enter] key to submit.

Note: Users can select Administrator Password and User Password to set the administrator password and user password respectively, the minimum length is 3 digits, the maximum length is 20 digits.

4.7. Boot

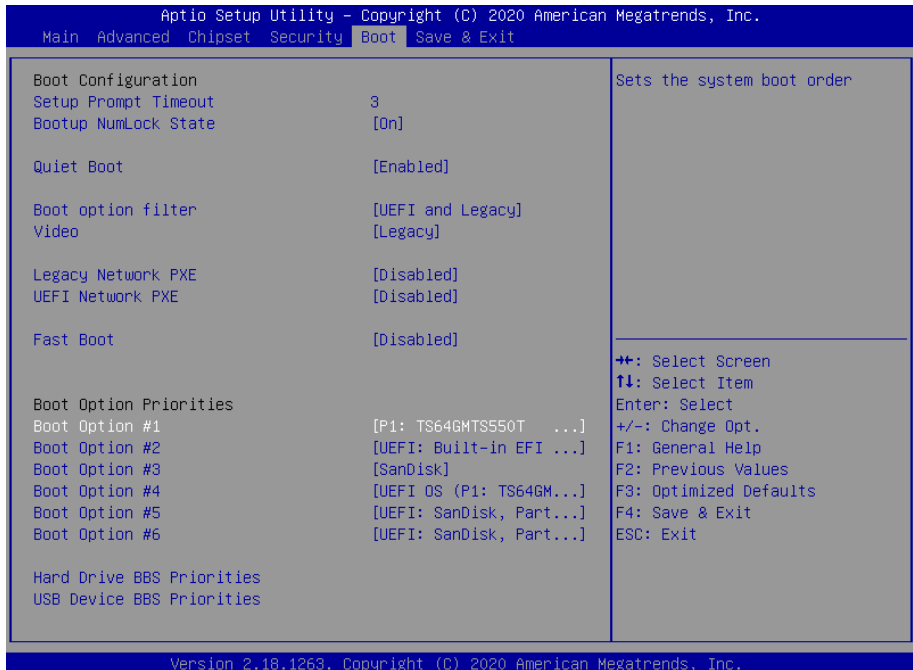

"Boot" menu contains the boot settings above. Users can set the boot logo or select the boot up devices, etc.

4.8. Setting the Boot Logo

Enter the **Boot** menu, select **Quiet Boot**, and then press F4 to save and exit, the system will take effect after reboot.

Setting	Description
Quiet Boot	<ul style="list-style-type: none"><li data-bbox="308 430 733 454">▶ Enabled: Logo will be displayed at boot up.<li data-bbox="308 462 985 513">▶ Disabled: Boot up the system and display the self-test screen, no logo, white label interface.

4.9. Setting Boot Option Priority

Set the system boot priorities.

Enter **Boot** menu. In "**Boot Option Priorities**", users can set the order of boot devices. Boot Option #1 is the first priority boot item, Boot Option #2 is the second boot item, and so on. Press F4 to save and exit, the system will take effect after reboot.

4.10. Save & Exit

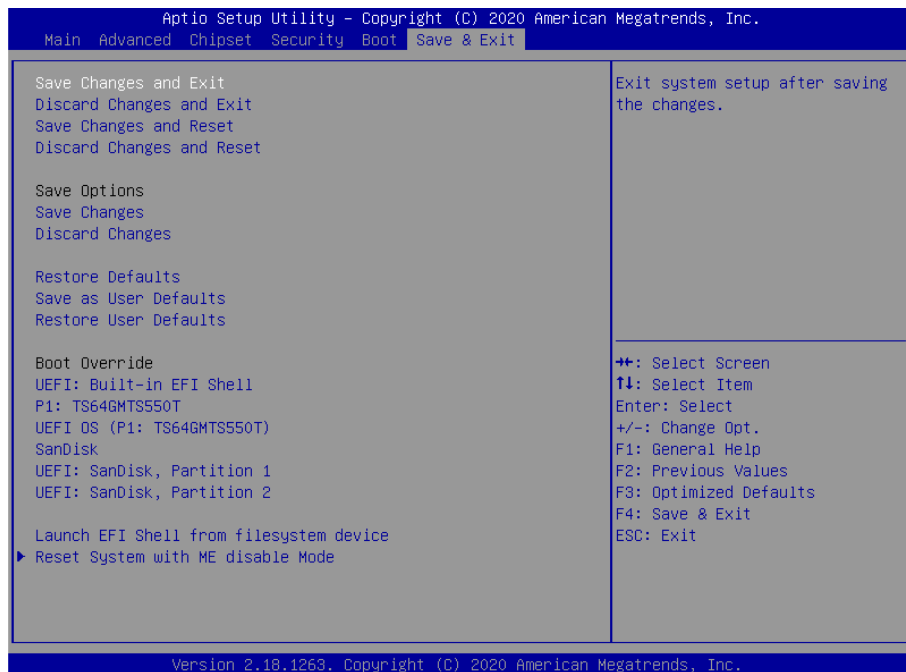

The Save & Exit menu displays the way to exit the BIOS setup utility. When users have completed the setup, users must save and exit for the changes to take effect.

Setting	Description
Save Changes and Exit	Saves the changes and quits the BIOS Setup utility.